

Accessories Catalog



**OPTIMA
STEAMER**



Explore our selection of accessories and parts for the OPTIMA STEAMER. Owning the world's best-selling dry vapor steamer can only get better when you add the right tools for the job.

Check out the OPTIMA STEAMER accessories designed specifically to help you get the job done quickly and effectively.



“OPTIMA STEAMER allows you to wash and sanitize anywhere and everywhere with little to no waste water.”



[85-50356] Steam Gun K26 with Nozzle 3.5

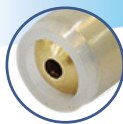

Ø3.5 Steam Nozzle
with Silicone Protector



Standard

Matching Accessories

[85-50202] Standard Steam Hose PTFE, 10m

[85-50365] Standard Steam Hose PTFE, 15m

[85-50366] Standard Steam Hose PTFE, 20m

※ Max. 300cc(0.08gal)/min. Dry steam

[85-50358] Steam Gun RL22 with Nozzle 5.5, Power



Ø5.5 Steam Nozzle
with Silicone protector



Power

Matching Accessories

[85-50364] Power Steam Hose PTFE, 10m

[85-50367] Power Steam Hose PTFE, 15m

[85-50368] Power Steam Hose PTFE, 20m

※ Max. 600cc(0.16gal)/min. Dry steam

► Using the RL22 Steam gun & Power steam hose achieves up to 70% more steam flow than using the K26 Steam gun & Standard steam hose.

Steam Temperature from Gun Nozzle

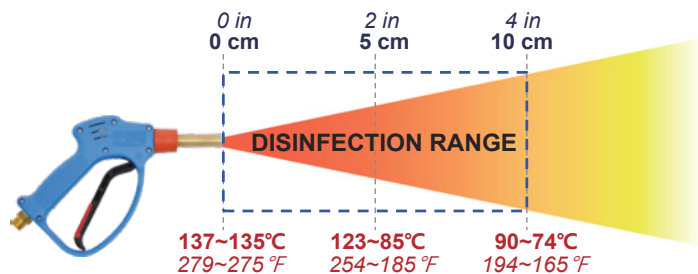

Lance Steam Guns K26 with Nozzle 3.5



Ø3.5 Steam Nozzle
with Silicone Protector

[85-50351] Steam Gun K26 (300mm)



[85-50266] Steam Gun K26 (500mm)



[85-50354] Steam Gun K26 (1000mm)



Lance Steam Guns RL22 with Nozzle 5.5



Ø5.5 Steam Nozzle
with Silicone Protector

[85-50084] Steam Gun RL22 (300mm)



[85-50267] Steam Gun RL22 (500mm)



[85-50087] Steam Gun RL22 (1000mm)



[85-50197] Steam Nozzle 3.5 + Hand Grip, 250D

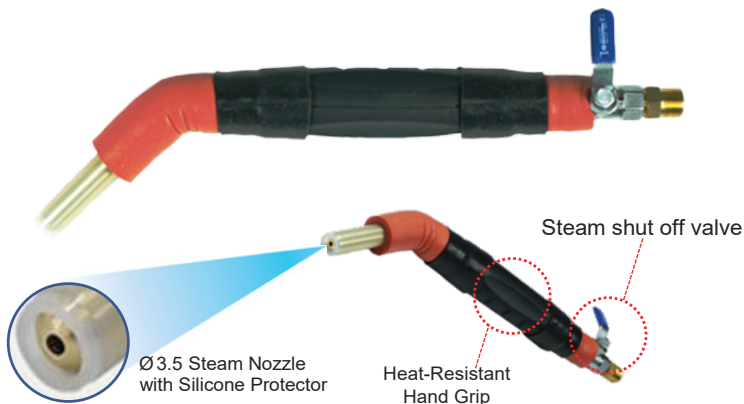

[85-50198] Turbo Steam Nozzle + Hand Grip, 250D



OPTIMA STEAMER



Quick Connectors for Accessories

For Light Attachments

[35-50336]
SCP30 Quick Plug

[35-50251]
SC30 Quick Coupler



EXAMPLE



For Heavy Attachments

[35-50040]
KPS45 Quick Plug

[35-50041]
KC35 Quick Coupler



EXAMPLE



Quick Connector Instructions

HOW TO CONNECT

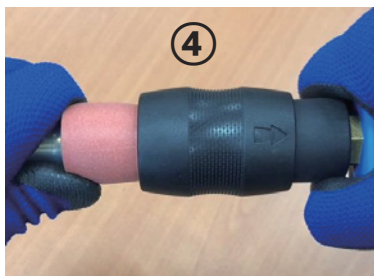
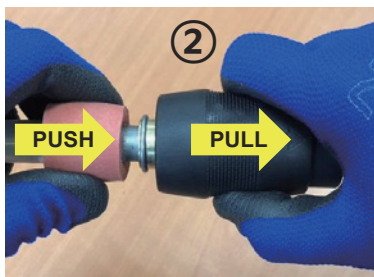
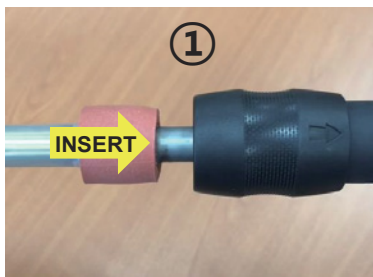

HOW TO DISCONNECT

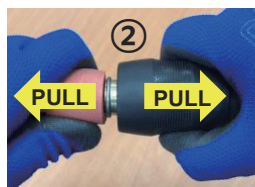
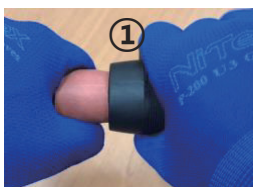

[85-50253] Steam Gun K26 with SC30 Quick Coupler



※ Example of usage

SCP30/40
Quick Plug

SC30
Quick Coupler



Matching Accessories

[85-50360]
Steam Nozzle 3.5



※ Ø3.5 Steam Nozzle
with Silicone Protector

[85-50382]
Silent Steam Nozzle



※ Reduces the pressure of
the steam spray as well
as the noise levels.

[85-50222]
Wide Steam Nozzle



※ Sprays steam to about
60° in a wider range.

Flat Steam Nozzles (SCP30 Quick Plug Applied)



※ Flat nozzles are suitable for HVAC cleaning

[85-50373] Flat Nozzle 50



[85-50359] Flat Fan Nozzle 50



[85-50212] Flat Nozzle 100

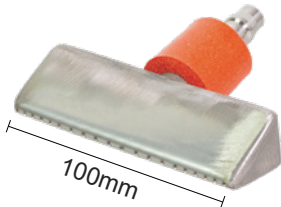

[85-50254] Turbo Steam Nozzle (SCP40 Quick Plug Applied)



※ Excellent for cleaning and restoring
patterns of carpets, mats and more



Steam Guns with KC35 Quick Coupler (Highly Recommended)

[85-50047]

Steam Gun K26 with KC35



※ Example of usage



[85-50130]

Steam Gun RL22 with KC35



KPS45
Quick Plug



KC35
Quick Coupler



Matching Accessories

[85-50145] Steam Nozzle 3.5



Ø3.5

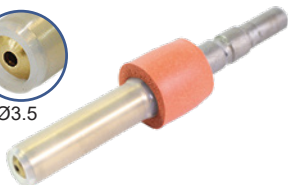

[85-50137] Steam Nozzle 5.5



Ø5.5

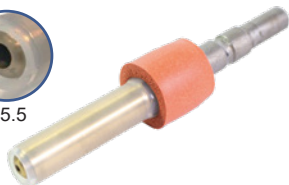

Steam Lances with Nozzle 3.5 (KPS45 Quick Plug Applied)



※ Ø3.5 Steam Nozzle
with Silicone Protector

[85-50079] Steam Lance 300mm (straight)



[85-50269] Steam Lance 500mm (straight)



[85-50061] Steam Lance 1000mm (straight)



Steam Lances with Nozzle 5.5 (KPS45 Quick Plug Applied)

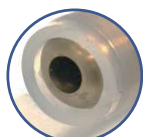

※ Ø5.5 Steam Nozzle
with Silicone Protector

[85-50190] Steam Lance 300mm (straight)



[85-50270] Steam Lance 500mm (straight)



[85-50193] Steam Lance 1000mm (straight)



Matching Accessories

[85-50274] Underside Cleaning



[85-53009] Floor Brush



KPS45
Quick Plug

※ Floor scrubbing and sanitizing with steam

[85-50056] Floor Spinner (KPS45 Quick Plug Applied)



※ Example of usage



※ 3 spinning steam
nozzles attached



※ The temperature
inside the floor spinner
is 100°C (212°F)



[85-50187] Sand Sanitizing Wand (KPS45 Quick Plug Applied)



※ Sand Sterilization at beach, playground, etc.

Brush Holder (45°) Attachments (Slide-On Accessories)



[35-50290]
Polyester Brush

[35-50291]
Polyester Brush

[35-50292]
Steel Brush

[25-50320]
Nylon Brush



Bent Lances with Brush Holder (KPS45 Quick Plug Applied)



[85-50076] Brush Holder Lance 100mm (45°)

[85-50077] Brush Holder Lance 250mm (45°)

[85-50264] Brush Holder Lance 500mm (45°)

[85-50064] Brush Holder Lance 700mm (45°)

[85-50063] Brush Holder Lance 1000mm (45°)

[85-50194] Brush Holder Lance 1200mm (45°)

Brush Holder (0°) Attachments (Slide-On Accessories)



[35-50293]
Plastic Scraper

[25-50308]
Metal Scraper



Straight Lances with Brush Holder (KPS45 Quick Plug Applied)



[85-50265] Brush Holder Lance 500mm (straight)

[85-50148] Brush Holder Lance 700mm (straight)

[85-50147] Brush Holder Lance 1000mm (straight)

[85-50146] Brush Holder Lance 1200mm (straight)

Weed Control Accessories (Weed Removal Tools)



- ※ Eradicate weeds using nothing but steam.
The Weed Control Accessories inject steam into the root of weeds, delivering a concentrated dose of high temp moisture that begins killing plants immediately, all without the use of toxic herbicides.
In a matter of days, the targeted plants will wilt and die, killed from the roots so the plant won't continue to regrow.



[85-50355] Steam Gun K26 with Weeding nozzle



[85-50138] Weed Control, Bell with KPS45 Quick plug



[85-50035] Weed Control, Brush with KPS45 Quick Plug



[85-50036] Weed Control, Spear with KPS45 Quick Plug

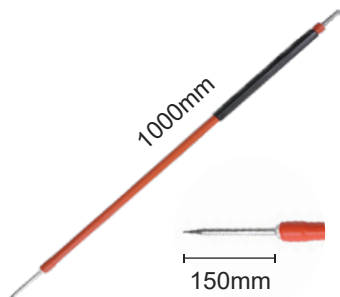

[85-50037] Weed Control, Flat Nozzle with KPS45 Quick Plug

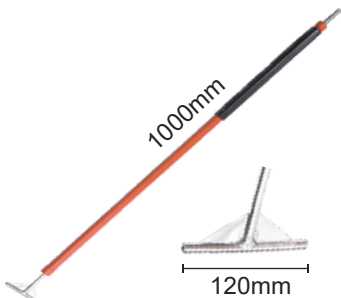

[85-50038] Weed Control, Roller with KPS45 Quick Plug

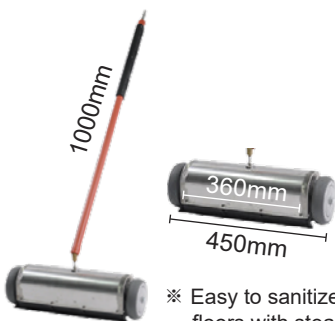

Mop Wands with Squeegee (Telescoping Pole Applied)

[85-50089] Mop Wand with Squeegee (0.8 ~ 1.2 meter)

[85-50091] Mop Wand with Squeegee (1.4 ~ 2.4 meter)

[85-50092] Mop Wand with Squeegee (1.5 ~ 3.6 meter)

[85-50093] Mop Wand with Squeegee (2.2 ~ 5.5 meter)

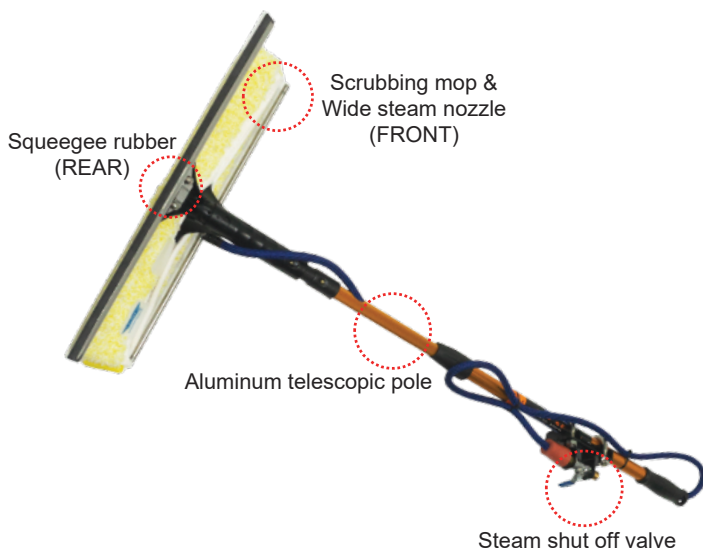

Spare Parts

[25-50343] Spare Mop 45cm



[35-50054] Spare Rubber 45cm



[85-50220] Steam Extractor Hand Tool



Matching Accessory

[85-50088]
Heat-Resistant
Vacuum Hose (3m)



※ Cleaning and Sanitizing carpets & mats
in combination with a vacuum cleaner



[85-50135] Barrel Cleaning Tool with Bimetal Thermometer



※ Using the OPTIMA STEAMER and our Barrel Cleaning Tool will use a fraction of the water you would use with a pressure washer, while killing more bacteria in the surface of the barrel and penetrate deeper. Produce swell in minutes - not hours - while preserving toasting flavors and character rather than flushing them away.

Conveyor Belt Cleaning Tools, Pneumatic type



	85-50201	85-50180	85-50200
Required Steamer	Optima 42K (SEII) and 27K (SEII, XE)		
Continuous Steam Pressure	42K : 7 bar, 27K : 5 bar		
Required Compressed Air	Air Compressor, 14.4 CFM @8 bar		
Working Air Pressure	73~116 psi (5~8 bar)		
Working Speed	150~1000 mm/s (5.9~39.4 inch/s)		
Recommended Belt	non-flat open surface type (plastic modular, metal wire, rollers)		
Material	aluminium, stainless steel		
(A) Air Inlet	standard air quick plug		
(B) Cleaning Width, Max.	610 mm / 24 in	1000 mm / 39 in	1220 mm / 48 in
(B) Cleaning Width, Min.	100 mm / 4 in		
(C) Mounting Width, Max.	970 mm / 38.1 in	1360 mm / 53.5 in	1580 mm / 62.2 in
(C) Mounting Width, Min.	300mm / 11.8 in		
Dimension (L x W x H) mm	1320 x 160 x 730	1710 x 160 x 730	1930 x 160 x 730
Dimension (L x W x H) inch	51.97 x 6.3 x 28.75	67.33 x 6.3 x 28.75	75.99 x 6.3 x 28.75
Weight	12 kg (26.5 lbs)	13.2 kg (29.1 lbs)	14.5 kg (32 lbs)

※ Compressed air required for the pneumatic type conveyor belt cleaning tools

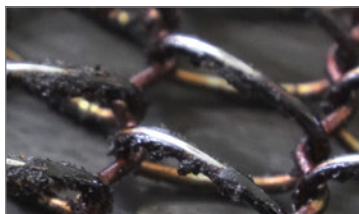
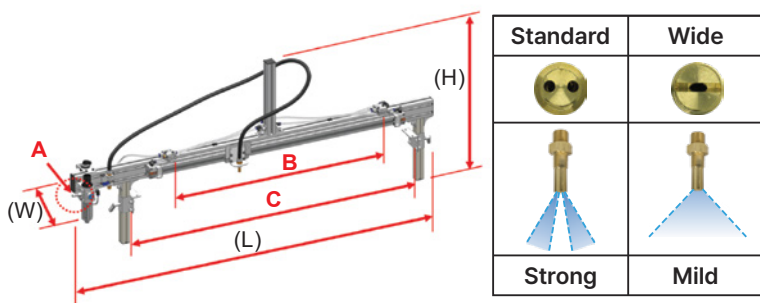

BEFORE

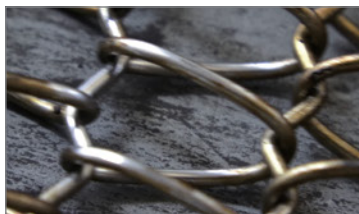

AFTER

[85-50082] Conveyor Belt Cleaning Tool, Basic



Similar Item

[85-50132] Conveyor Tool, Basic type (Mounting Width ~1200mm)

[85-50083] Conveyor Belt Cleaning Tool, Suction type



Similar Item

[85-50131] Conveyor Tool, Suction type (Mounting Width ~1200mm)

Miscellaneous Parts & Accessories

[88-83011]

Microfiber towel

Best

FBZ

20 sheets

[88-83012]

Microfiber towel

Warp Knitted

20 sheets

[88-83013]

Microfiber towel

Synthetic Wool

20 sheets

[32-21061]

Feed Coupling



[22-22105]

Nozzle Protector

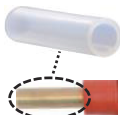

(14 pcs)



[18-83002]

Gloves (coated)



[85-50005]

Shutter K26 with O-ring



[85-50185]

Shutter RL22 with O-ring



[85-56026] LT5 Water Softener with Bracket



- ※ Minimize maintenance, increase the lifespan of your machine, and save money. The best means of improving your water quality, and we only recommended solution for preventing is to use a salt-based water softener and we've got one that will work great with the OPTIMA STEAMER—the LT5. What's better is that LT5 was designed to be installed on the back of OPTIMA STEAMER and to provide a mobile water softening solution that goes where your OPTIMA STEAMER goes. Get the best performance out of your machine. Connects via the Direct Water Feed connection. Recharge frequency varies based on water hardness and usage. Recharge using table salt.



OPTIMA STEAMER

Inquiries: sales@sjecorp.com

WWW.SJECORP.COM



OPTIMA STEAMER

Manufacturer Information

SJE Corporation, Ltd.

78-21, Sandan 7-ro,

Jeongwan-eup,

Gijang-gun, Busan

South Korea

+82 51-521-3200

sales@sjecorp.com

www.sjecorp.com